



Digital Thermostat

Models: VS30W and VS30B



INSTALLER / USER MANUAL

Contents

Contents

Box Contents
Introduction
Product Compliance
Installation
User Guide
Parameter Settings
Installers Notes
Warranty

Icons used in this manual:



Safety



Important info



Your benefit

For latest PDF installation
guide please go to
www.salus-controls.com

Box Contents



1 x Installer / User manual



4x AAA Batteries



Fixing screws



VS30

Product Compliance & Safety Information

INTRODUCTION

Thank you for purchasing the room thermostat VS30. The VS30 is a 230V digital thermostat which offers simple temperature control of your heating system.

By purchasing the VS30 you have decided on a digital room thermostat which allows you to adjust surface heating appliances individually, such as underfloor, wall or panel heating. A clear energy saving is possible by reducing temp.



Product Compliance

This product is CE compliant and meets the following EC Directives Electro-Magnetic Compatibility Directive 2004/108/EC
Low voltage Directive 2006/95/EC



Safety Information

Use in accordance with the regulations. The VS30 is to be used for room control of hot water heating systems inside the house.



Installation

This product must be fitted by a competent person, and installation must comply with the guidance, standards and regulations applicable to the city, country or state where the product is installed. Failure to comply with the requirements of the relevant guidance, standards and regulations could lead to injury, death or prosecution.



Always isolate the AC mains supply before installing or working on any components that require 230V AC 50Hz supply.

We hope you enjoy this product...

Product Compliance & Safety Information



Sources of danger

The thermostat must be disconnected from mains supply before removing the cover.



230V AC



Emergency

Switch off the voltage to the individual thermostat wiring centre or complete system.



Installer parameter settings

The VS30 is equipped with installer parameter section. This must only be entered by the installer or competent person. Changing these parameters can have a serious effect on your heating system. See page 41.



For the installer

Please enter any parameter changes in the installer notes section.

Installation – Terminal Connections

Understanding your terminal connections

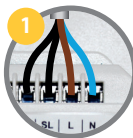
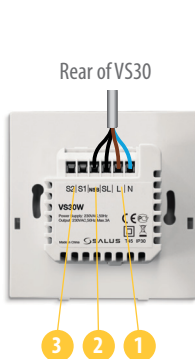

Power Terminals 230 Vac

Used for supplying power to the unit and switched output.

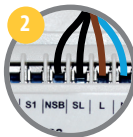

NSB (Night Set Back) Connection

Used for a 230V output to other thermostat. See page 8.



Sensor Terminals (Optional)

Can be used for external AIR or Floor sensor.

Installation – Thermostat Mounting



Gently remove front housing.



Gently remove front housing.

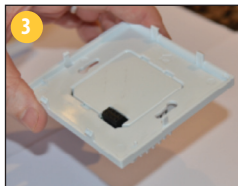

Wall Mounting

For wall mounting, mark and mount the rear case to the wall. The VS30 is suitable for wall boxes with a centre hole distance of : 60mm

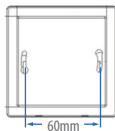

Only for flush mounting boxes with horizontal fixing holes.

Installation – Thermostat Mounting



Mounting position and installation

To ensure trouble free operation and efficient control, the VS30 room thermostat is best positioned in a draft free area, and at 130cm from the floor. Do not position the thermostat near any heat source, behind curtains, direct sunlight or an area of high humidity.

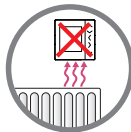
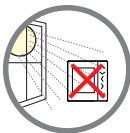
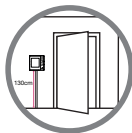

Not to be positioned on an exterior wall.

Installation – Terminal Connections

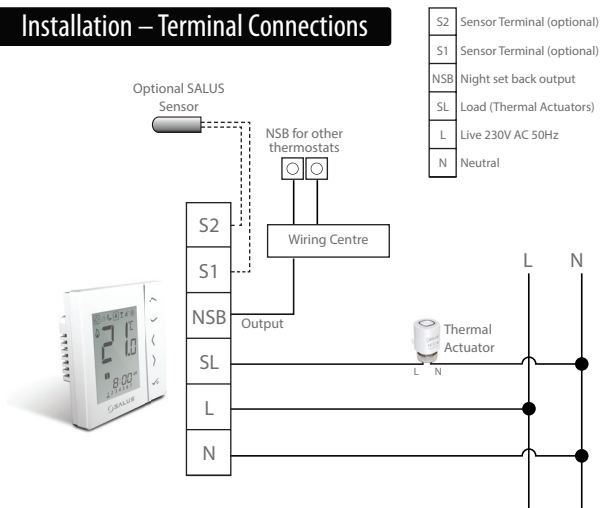

Installation – Terminal Connections



Check that the wiring is completed for:

- 1 Power Terminals
- 2 NSB (Night Set Back) Connection
- 3 Sensor Terminals (if applicable)

You are ready to secure the rear housing to the wall box



Please use the screws provided



Ensure the orientation arrow is pointing upwards.



Installation – Thermostat Mounting



Fit the front housing to the rear housing



Ensure the pin connections are aligned



- 1 Align the front housing at the top edge.







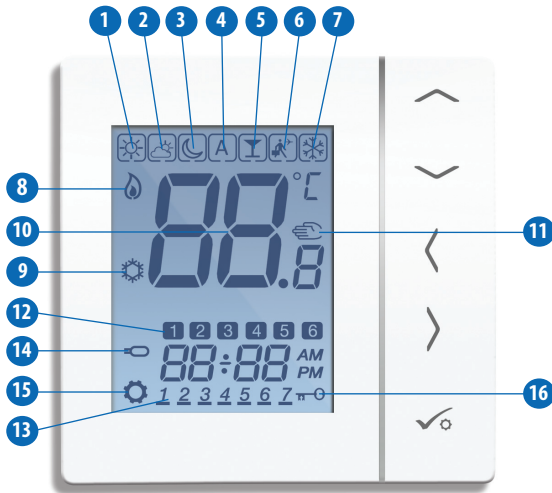



- 2 Lightly press until you hear a positive click.







Installation – LCD Graphics





Installation – LCD Graphics

	BOX means to select the mode e.g.  means the current setpoint is Hi temp,  means the Hi temp is not selected.	
	Sunny: Hi comfortable temperature.	1
	Cloudy: Middle comfortable temperature.	2
	Moon: Low comfortable temperature.	3
A	Programmable thermostat Program mode indicator: Indicates program is running, Auto On or Auto Off. For group thermostat this indicates that it is a member of a group.	4
	Party indicator: When Party mode is active.	5
	Vacation indicator: When Vacation mode is active.	6
	Frost protection indicator: Frost protection is active, not available in cooling mode (if applicable).	7









Installation – LCD Graphics

ICON	FUNCTION	
	Heat indicator: Indicates heat is required.	8
	Cool mode indicator: Indicates cooling is required (if applicable).	9
	Temperature indicator: Display the room temperature. Display the set-temp. Also used to show the other information.	10
	Temporary manual override indicator: If the set temperature is changed when in program mode, the hand will appear until the next program start time.	11
	Programs number indicator: In AUTO program mode or Temporary override is running, it means the current program running.	12
	Day indication: 1 = Monday.	13

Installation – User Interface

ICON	FUNCTION	
	Floor sensor probe indicator: Show only when Air + Floor sensor is connected.	14
	Setting indicator: Indicates the unit is in setting mode when program setting. Indicate's the manual mode.	15
	Keylock indicator: Shows that keys are inactive.	16

Installation – User Interface

KEY	FUNCTION
 OR 	<ol style="list-style-type: none"> Increase or decrease setpoint temperature. Increase or decrease Day, Clock, Timer, Party and Holiday. Select installer parameter value.
 OR 	<ol style="list-style-type: none"> Mode selection. Long press to return to home display without saving. Short press to return to the previous screen when it is in user/installer setting mode.
	<ol style="list-style-type: none"> OK key: Short press to confirm selection. Long press to save and exit. Long press to enter the user settings.
 5 SECONDS	Lock/Unlock.
 5 SECONDS	Enter Installer parameter settings.
 5 SECONDS	Test mode.

Installation – First Power Up

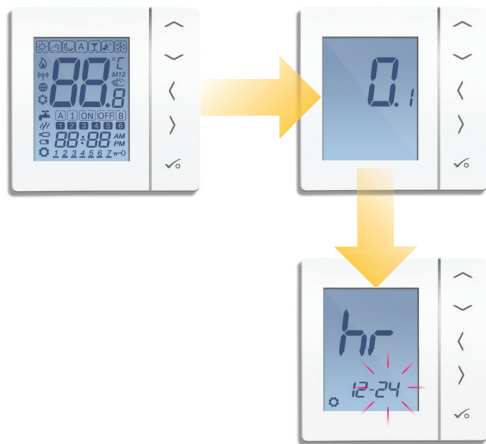

Installation - Graphics Key



Press once



Press x amount of times



Hold for five seconds



Flashing



ON first power up.
Proceed to page 19



Short press to back up



Short press to save and
long press to save and exit



User Guide - Setting time and date

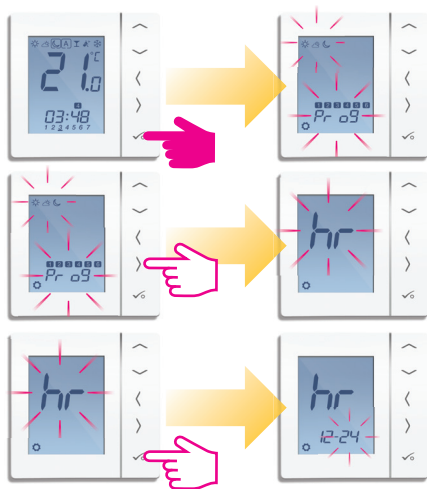

User Guide - Setting time and date

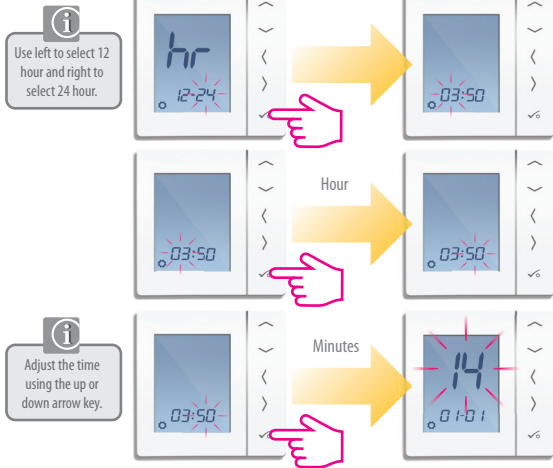

User Guide – Understanding Temperature Levels - Heating



Highest Temperature typically used for early morning and early evening.
Typically 20 Deg C



Mid Temperature typically used for times of day when you are active around the home.
Typically 19 Deg C



Lower Temperature typically used for unoccupied or sleep times.
Typically 17 Deg C for UFH or 15 Deg C for radiators



Frost Temperature typically used for periods of long absence or holidays.
Typically 5 Deg



Your thermostat comes preset for the above temperatures. These can be adjusted. Please see page 37.

User Guide - Understanding Temperature Levels - Cooling



See device setting D18, section on page 44



Occupied Temperature. Typically 22°C



Unoccupied Temperature Typically 40°C

This avoids cooling being active when the property is unoccupied.



Evening Temperature Typically 26°C



Your thermostat comes preset for the above temperatures.
These can be adjusted. Please see page 37.

User Guide - Default Heating Schedule .1

Monday to Friday

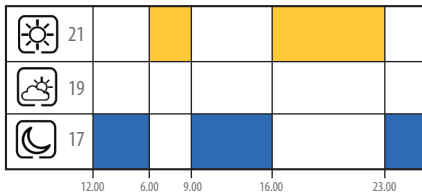

Saturday to Sunday

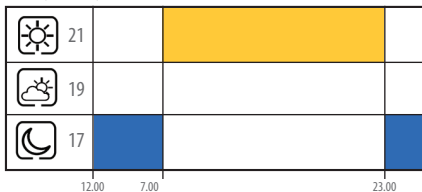

User Guide - Optional Heating Schedule .2

Monday to Friday

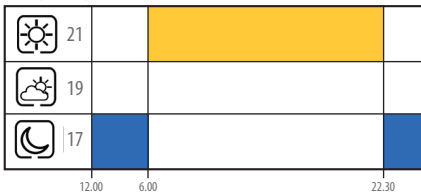

Saturday to Sunday

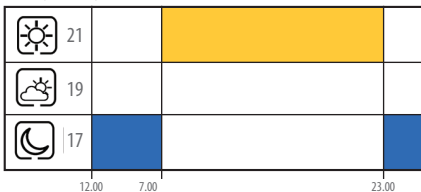

User Guide - Optional Cooling Schedule .2

Monday to Friday

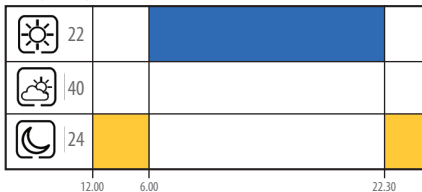

Saturday to Sunday

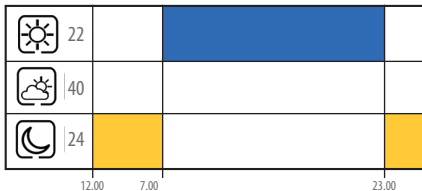

User Guide – Setting the Temperature Schedule

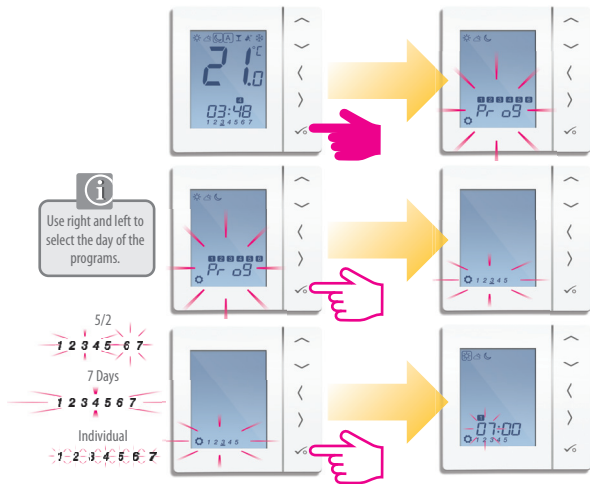

User Guide – Setting the Temperature Schedule



User Guide – Setting the Temperature Schedule



Repeat through to program 4.
If you require a 5th or 6th program enter a time
and select your temperature ☀️ ☁️ 🌙



To remove a program out set the time to ---:--.



When you set the ☀️ ☁️ 🌙 temperature, the schedule will respond to those temperatures. See page 37 on how to change ☀️ ☁️ 🌙

User Guide - Temporary Override



Use the up or down arrow key to view your program set temperature.



Temporary override allows you to increase the temperature or decrease it to the desired setting until it reverts back on the next program time.



Use the up or down arrow key to adjust the temperature to the setting you desire.

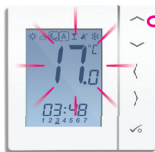

User Guide - Temporary Override

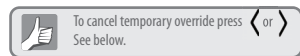
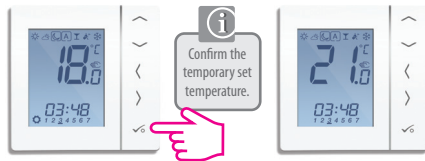

User Guide - Permanent Override

Setting permanent low temperature

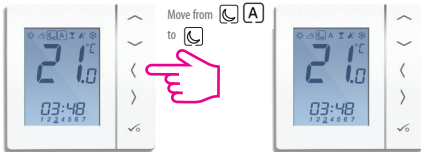

Use the up or down arrow key to view your set temperature. See page 35.



Repeat for



if required



To adjust your permanent override temperature follow the steps on page 35.

User Guide - Party Mode



The party mode is an option that enables temperature for a period of time. You select up to 9hr 50min.



Use the right arrow to select the party mode.



Use the up arrow to select the hr/min.



Press tick to confirm and it will start to count down.



User Guide - Holiday Mode

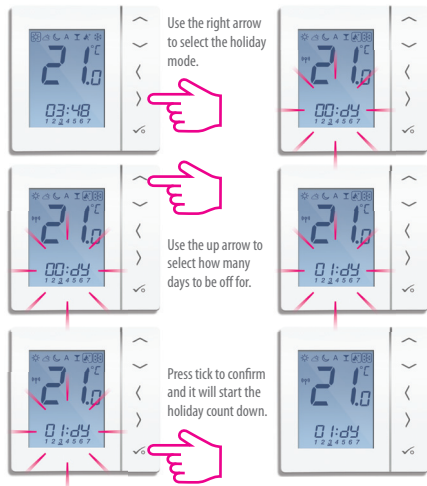

User Guide - Frost Protection



Installation - Entering Device Menu

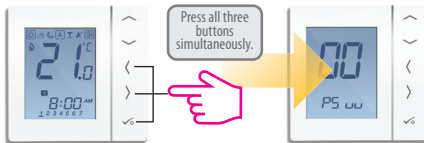

i If you need to change device parameters follow the steps below.

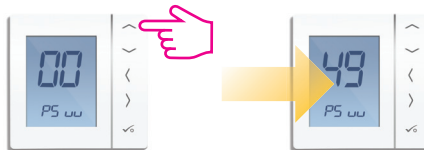

i Must only be entered by the installer.



i This is the first screen of the device menu.

Installation - Device Parameters

DX	FUNCTION	SYSTEM SETTING	DEFINITION	DEFAULT
D01	Heating Control	0	Pulse Width Modulation	0
		1	On-Off 0.5 Deg C +/- 0.25 Deg C	
		2	On-Off 1.0 Deg C +/- 0.5 Deg C	
D02	Room Temperature Offset	-3.0 to 3.0 Deg C	Temperature Offset from Measured Temperature to Compensate for any error	0 Deg C
D03	Sensor probe or Cylinder thermostat connection	0	Sensor stat not Connected	0
		1	Sensor stat Connected	
D04	Sensor probe used as air sensor or floor sensor	0	D03 must be set to 1 then external sensor be used as Air sensor. There will be no internal temp measurement	0
		1	D03 must be set to 1 then external sensor used for floor protection. Internal temp is measured by stat	
D05	Cooling Control	1	On-Off 0.5 Deg C +/- 0.25 Deg C	2
		2	On-Off 1.0 Deg C +/- 0.5 Deg C	
D06	Actuator type	0	NO Normally Open	1
		1	NC Normally Closed	
D07	Valve protection	0	Disable	1
		1	Enable	

Installation - Device Parameters continued

DX	FUNCTION	SYSTEM SETTING	DEFINITION	DEFAULT
D08	Frost Set point Temperature	5-17 Deg C	Required Temperature for frost protection and holiday mode	5 Deg
D09	Hour Format	0	12	1
		1	24	
D10	N/A	N/A	N/A	N/A
D11	Daylight Saving Time (DST)	0	OFF	1
		1	ON	
D12	Heating Set point Limit	5-35 Deg C	Maximum temp that can be set for heating	35 Deg C
D13	Cooling Set point Limit	5-40 Deg C	Maximum temp that can be set for Cooling	5 Deg C
D14	Floor sensor High Limit Temperature	6-45 Deg C	Output relay will be switched off when temp is reached for floor protection	27 Deg C
D15	Floor sensor Low Limit Temperature	6-45 Deg C	Output relay will be switched on when temp is reached for floor protection	10 Deg C
D16	Floor sensor Limit for cooling	6-45 Deg C	Output relay will be switched off when temp is reached for floor protection	6 Deg C

Installation - Device Parameters continued

DX	FUNCTION	SYSTEM SETTING	DEFINITION	DEFAULT
D17	Preset program selection	1-5	Select 1-5 of the default programs	1
D18	Heat/Cool mode selection	0 or 1	0: heating mode 1: cooling mode	0

Installation - Technical Detail

Model	VS30W/ VS30B
Type	Electronic programmable room thermostat, digital room thermostat designed for 230V AC applications
Programming Modes	User selectable for 5/2, ALL and Individual day options
Program Number	1-6 Selectable
Modes	Party, Vacation, Program and Frost
NSB	230V Output from external clock
Override	Permanent and temporary
Frost Protection	5°C Adjustable
Power Source	230V AC 50Hz
Rating	3 Amp
Temperature Scale	5 to 35°C, tolerance 0.5°C
Heat/Cool	Global changeover using communication bus and external input to the wiring centre
Sensor	Air or floor protection.
Device Parameters	See page 42 for full list of functions
Operating Temperature	0 to 50°C
Storage Temperature	-20 to 60°C

Installation - Notes

.....

.....

.....

.....

.....

.....

.....

.....

.....

.....

.....

.....

.....

.....

.....

.....

Warranty

SALUS Controls warrants that this product will be free from any defect in materials or workmanship, and shall perform in accordance with its specification, for a period of five years from the date of installation. SALUS Controls sole liability for breach of this warranty will be (at its option) to repair or replace the defective product.

Customer Name:

Customer Address:

..... Post Code:

Tel No: Email:

Engineers Company:

Tel No: Email:

Installation Date:

Engineers Name:

Engineers Signature:

SALUS Controls plc

SALUS House
Dodworth Business Park South,
Whinby Road,
Dodworth, Barnsley S75 3SP, UK.

SALES: T: +44 (0) 1226 323961
E: sales@salus-tech.com

TECHNICAL: T: +44 (0) 1226 323961
E: tech@salus-tech.com

www.salus-controls.com



SALUS Controls is a member of the Computime Group

Maintaining a policy of continuous product development SALUS Controls plc reserve the right to change specification, design and materials of products listed in this brochure without prior notice.

Issue Date: April 2014

00086/2